

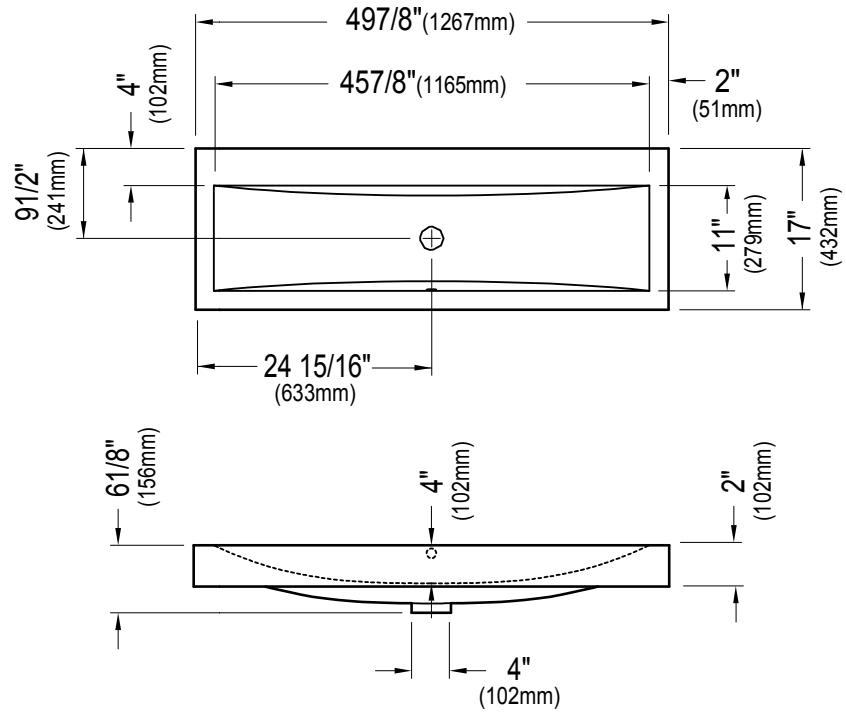

Produits Neptune

ZEN 50R

Above Counter Sink



* All dimensions are approximate and subject to change without notice.
Please refer to the installation guide before beginning the installation.